

透水側溝PU-600構造図 S=1/10

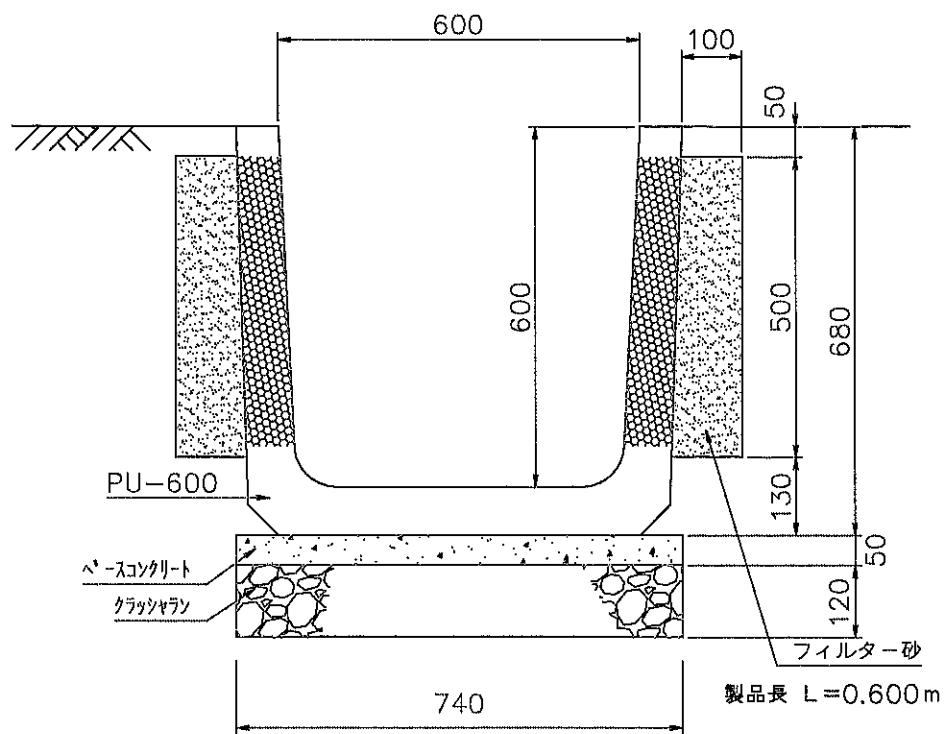

透水側溝PU<sub>s</sub>-600構造図 S=1/10

