

透水側溝PU-360B構造図 s=1/10

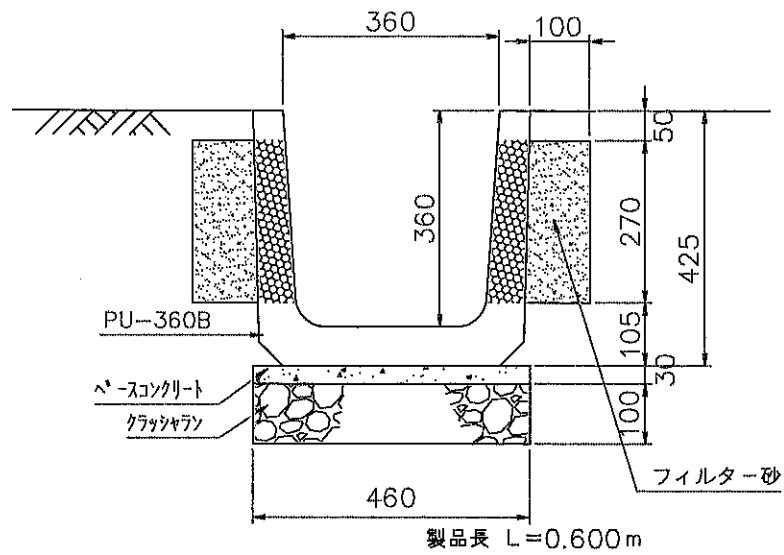

透水側溝PU_s-360B構造図s=1/10

